

ROLLERS

WALL • GROUND • IN-GROUND
POOL ROLLER SOLUTIONS





Covering your pool

It takes a lot of energy to heat a pool, so it's essential to lock in that heat while your pool isn't in use. We offer a wide range of pool cover and roller solutions that are not only great for the environment but will save you money too.

Rollers Benefits

One of the most significant issues when covering a pool is where does the cover go? A roller not only stores and protects your cover but also makes its use so much easier.

We have roller solutions to suit any situation. Whether you want it kept on a wall, under a seat, wheeled away or completely hidden underground.

Although our rollers are fully compatible with most Thermal and Bubble covers, we highly recommend using a Sunbather cover matched with one of our rollers for superior longevity and reliability.

Did you know?

- Pools lose 92% of their heat through the waters surface, with the remaining 8% lost through the walls and floors.
- Water lost through evaporation from an uncovered pool can equal twice that pool's entire volume of water each year.
- A pool cover will extend your solar heated pool swimming season.
- A pool cover will half your running costs when using a gas heater or heat pump.
- A pool cover will save you money on chemicals.

Why Sunbather

After pioneering the Solar Pool Heating industry in Melbourne in 1974, Sunbather to this day continues to be the industry leader, setting the standard for quality and innovation.

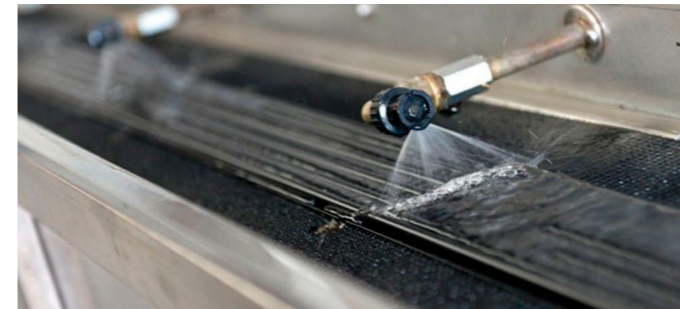

Industry Leaders Since 1974

Innovation is at the heart of Sunbather which has been recognised by the industry making Sunbather the most awarded pool heating and covers company in Australia.



Quality matters

Quality and reliability are critical. Our products are built to the highest standard utilising carefully selected high-grade materials and premium finishes.



Designed & built in Australia

Servicing Australia and New Zealand, Sunbather continue to engineer and manufacture pool systems right here in Australia.



Along with our **Solar heating** range Sunbather **Thermal Covers** are all **Climate Care Certified**

Downunder

IN-GROUND • IN-DECK/PIT



PHOTOS: DAVID COOK PHOTOGRAPHY

Our award-winning Downunder Rollers, the In-Ground or In-Deck/Pit variants, keep your Sunbather Thermal Pool Cover out of sight.

If you are after a premium roller with a discrete architectural finish, all while maximising your pool area, look no further than our award-winning Downunder Roller series.

Chosen again by The Block 2021, our Downunder Rollers enabled contestants to maximise their spatial allowance and achieve an unmatched prestige finish.

Our Downunder Rollers hide out of sight, leaving your pool area's aesthetics uninterrupted by bulky poolside rollers. A precision-finished aluminium lid hides the Downunder's robust stainless-steel roller underneath your deck, concrete or paved area.

To deploy your cover from our Downunder Roller series, the aluminium lid is flipped open, and your cover is easily pulled out into position. To roll up the pool cover, take advantage of our easy to use 2:1 ratio, waist-height handle. Simply wind it up and close the lid.

Our manual variants come in two distinct models; our In-Ground model is suitable for paved areas, whilst our In-Deck/Pit model is suitable underneath decking or in a concrete pit. For further ease of use, our In-Deck/Pit semi-automated Downunder Roller upgrade will retract your pool cover away for you at the click of a button.

So maximise your entertainment area with a prestige quality hidden roller from an Australian made brand that you can and trust.



Low friction gears

- The most robust gears on the market
- Easy to use 2:1 Ratio
- Unique low friction design



Stainless Steel Frame

- State-of-the-art single piece design
- Constructed with high quality stainless steel with no weak points
- No onsite assembly required



Aluminium Tube

- Single piece tube for superior strength
- 114mm diameter gives greater rigidity



In-Ground -PVC Plastic Case

- Thick PVC plastic will last in the ground and not deteriorate or corrode
- Designed in a single oval shaped piece for easy installation
- Secured with metal ties (to REO) front and rear



Aluminium Lid

- Lite and easy to use (safe for fingers)
- Durable for foot traffic
- Aesthetically superior
- Standard aluminium silver lid
- Optional colour upgrade

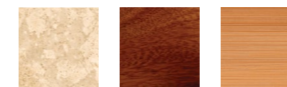

Optional Upgrade



In-Deck/Pit - Semi Automatic

- Discretely hidden motor in 150mm diameter roller tube
- Motorised In-Deck/Pit roller will retract your thermal cover with the use of a remote control (manual deploy).

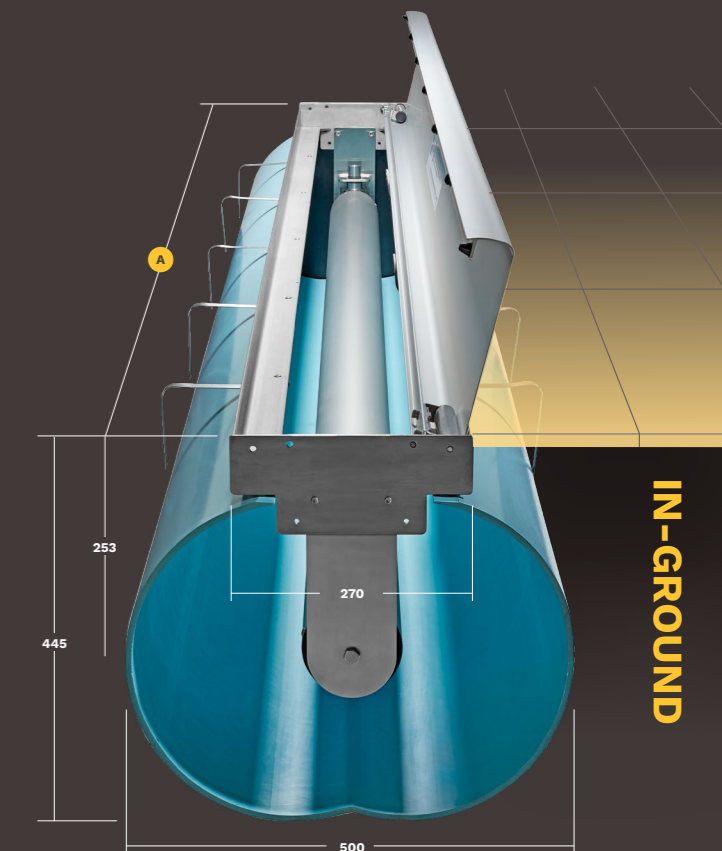
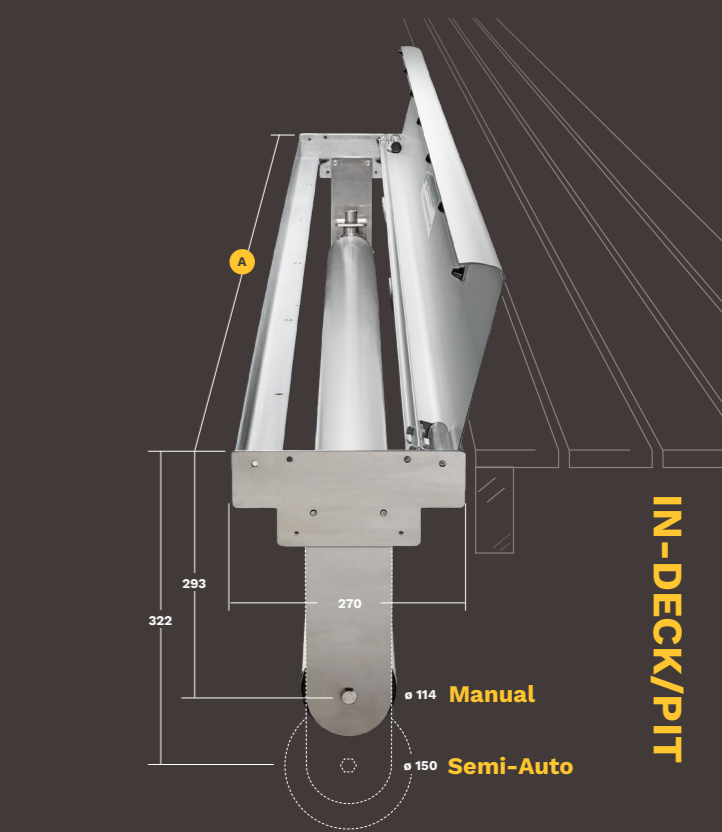

STANDARD ROLLER LENGTHS	MAX COVER LENGTHS (IN-GROUND)
3.4m waterline width up to 3.0m	10m max Thermal/Bubble Cover
3.9m waterline width up to 3.5m	
4.4m waterline width up to 4.0m	MAX COVER LENGTH (IN-DECK/PIT)
4.9m waterline width up to 4.5m	20m max Thermal/Bubble Cover

Please refer to the installation guide for more technical details

Coverroll Ground



- Strong 114mm diameter one-piece tube
- Polished stainless-steel triangular end frames and handle
- Two available models. A model with rubber feet and a model with multi-directional castors and two 10mm drop pins.



Coverroll Wall



- Strong 114mm diameter one-piece tube
- High quality polished stainless steel end-frames and handle
- Direct drive handle winder

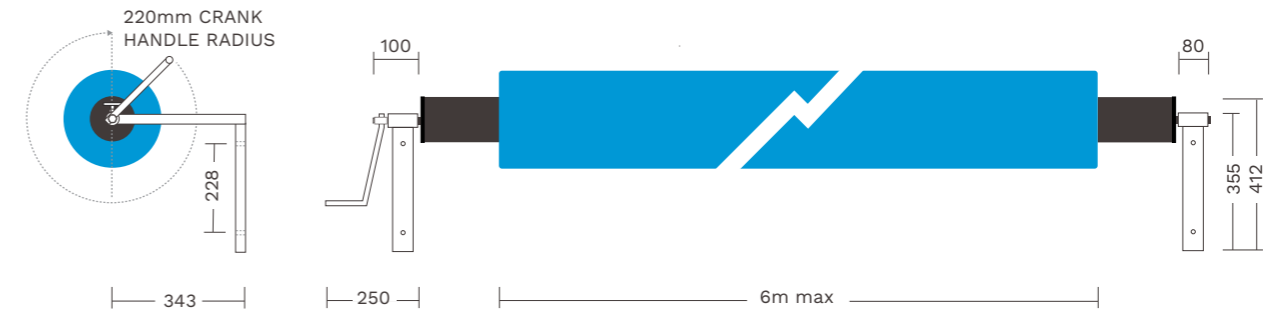
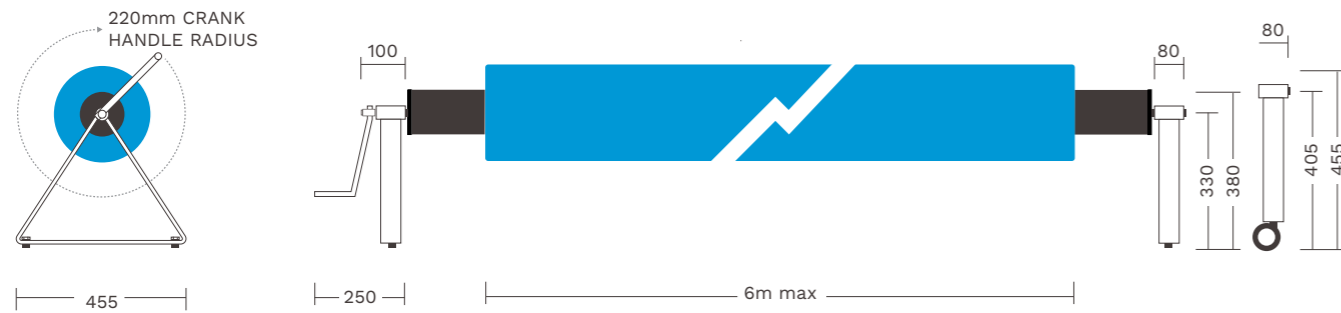

Coverroll Pro Ground



- Strong 114mm diameter one-piece tube
- Commercial strength polished stainless steel T-end frames and handle
- High-quality multi-directional lockable castors
- Alternatively directly fix to the pool coping without castors
- Optional upgrade to 150mm diameter one-piece tube for larger pools

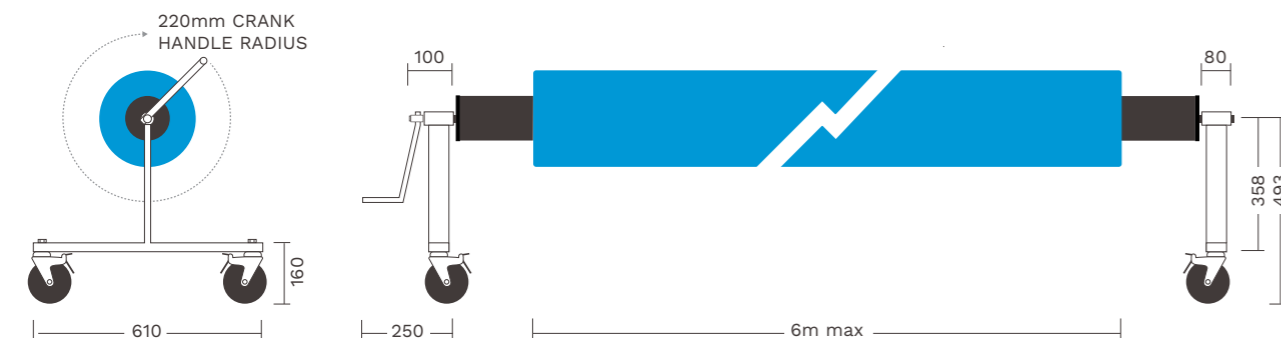

Coverroll Gear Drive



- Strong 114mm diameter one-piece tube
- High quality polished stainless steel end-frames
- Low friction gears with a 2:1 ratio
- Operated from a standing position

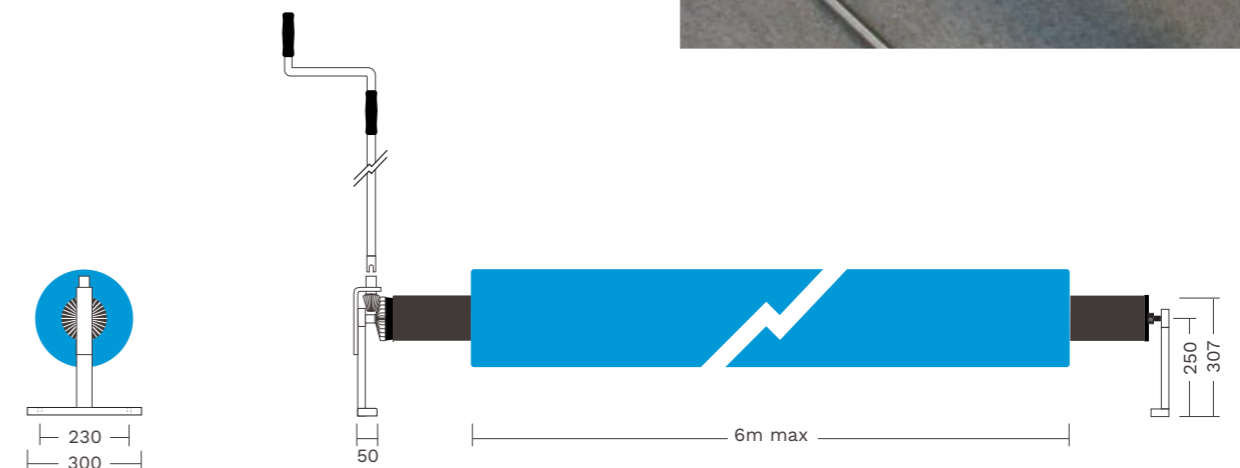

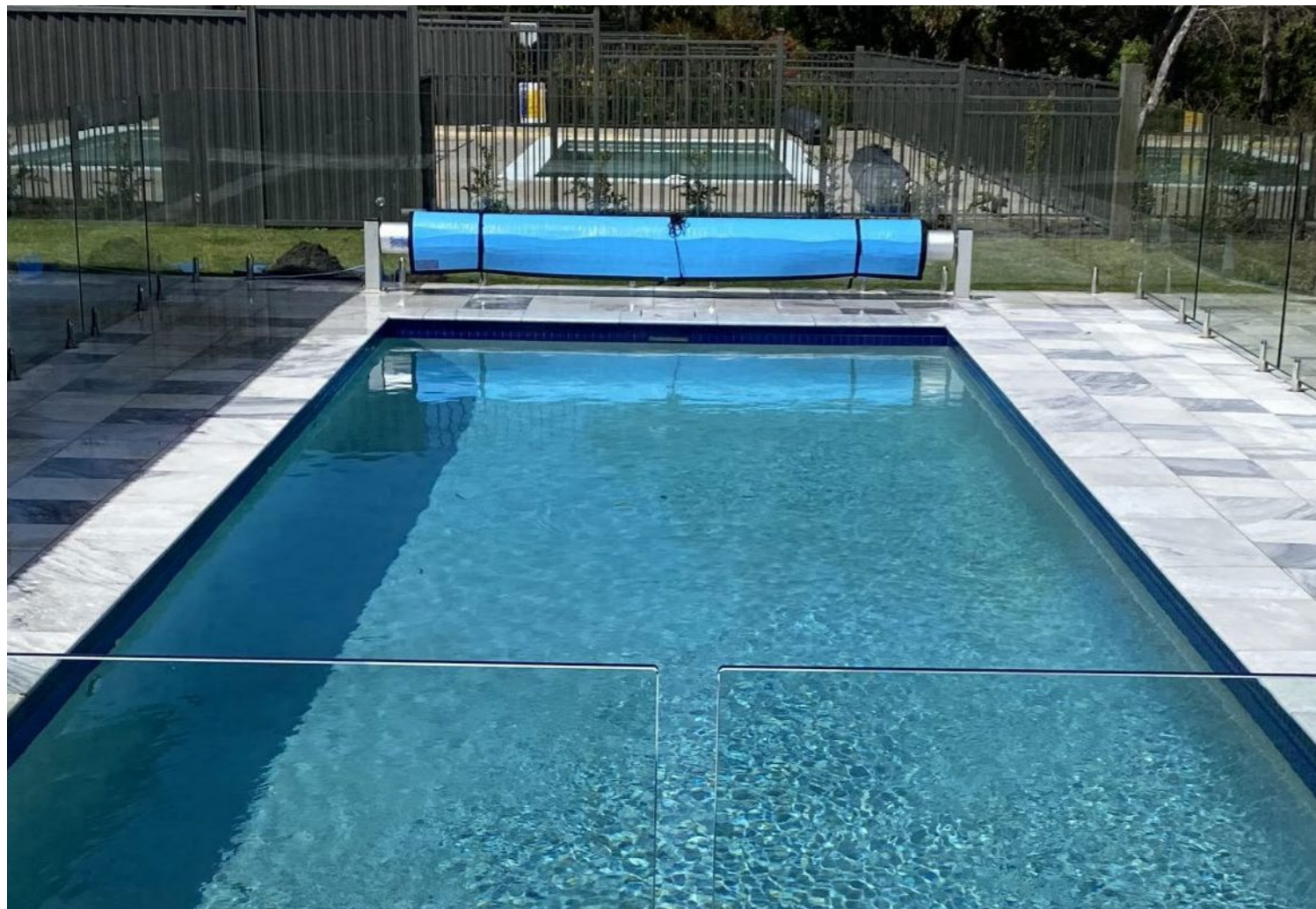

Coverroll Motorised Ground

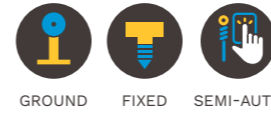

- Strong 200mm diameter one-piece tube
- Sturdy anodised 100mm legs
- Discreet 240v mains powered European internal tube motor
- Semi-automatic roller with hand held remote (auto retract/assisted deploy)



Coverroll Seat



- Strong 114mm diameter one-piece tube
- Solid HDPE end frames
- Low friction gears with a 2:1 ratio
- Operated from a standing position
- Suitable for pools up to 5m wide and 15m long
- Standard aluminium silver seat
- Optional seat colour upgrade

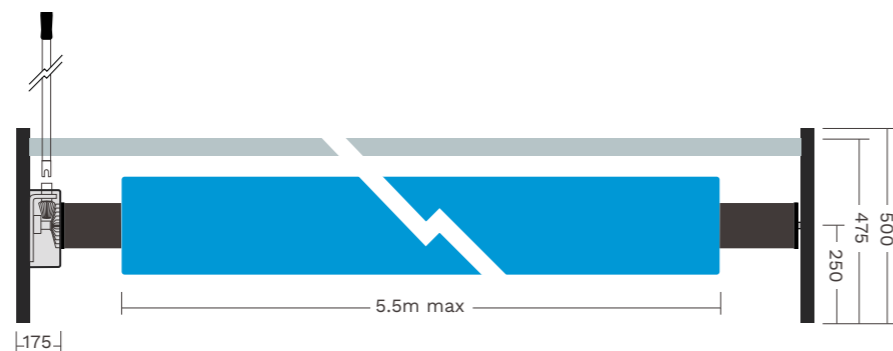
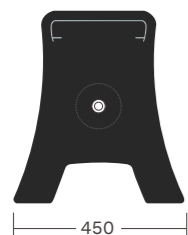
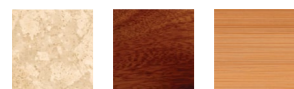

Coverroll Motorised Wall



- Strong 200mm diameter one-piece tube
- Sturdy anodised wall brackets
- Discreet 240v mains powered European internal tube motor
- Semi-automatic roller with hand held remote (auto retract/assisted deploy)

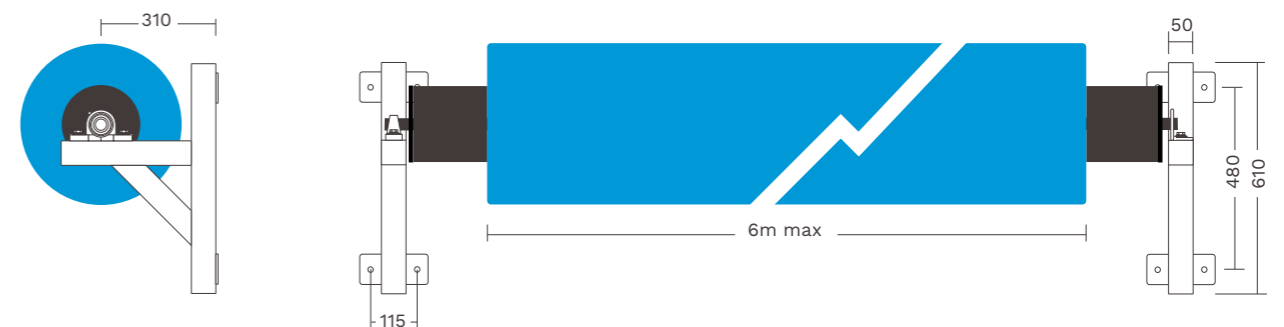



Thermal Covers

COMPATIBLE ROLLER COVER

Our Thermal Pool Covers are a cut above the rest with superior heat retention, durability, aesthetics and savings.

A heated swimming pool left uncovered can lose twice its volume over one year. However, our Thermal Pool Covers will save 99% of this water and is exceptional at retaining heat overnight. Moreover, our Thermal Pool Covers will protect your pool from debris and algae-growing sunlight, causing your pool to require fewer chemicals. Therefore, you will save on energy, water and chemical costs.

A Sunbather Thermal Pool Cover is crafted using high quality, multi-layered, foam-based material with a smooth finish to obtain the most efficient, aesthetically pleasing and durable pool cover possible.

- High quality, multi-layered, foam-based material
- Climate Care Certified
- Designed & manufactured by Sunbather in Australia
- Save 99% of water
- Exceptional at retaining heat overnight
- Protect your pool from debris and algae
- Will fit all Sunbather rollers



Roller Size	Cover Length	2mm Thermal	4.5mm Thermal
114 Roller			
	5m	160mm	200mm
	10m	185mm	255mm
	15m	210mm	300mm
	20m	230mm	345mm
150 Roller			
	5m	190mm	225mm
	10m	215mm	275mm
	15m	235mm	320mm
	20m	255mm	360mm
200 Roller			
	5m	230mm	260mm
	10m	255mm	305mm
	15m	280mm	350mm
	20m	295mm	385mm

Rolled up Diameters for 2mm and 4.5mm Thermal with 114 Roller, 150 Roller and 200 Roller. Approximate only, to be used as a guide.



Along with our **Solar heating** range Sunbather **Thermal Covers** are all **Climate Care Certified**

MADE IN
AUSTRALIA

QUALITY AUSTRALIAN MADE
POOL COVERS & ROLLERS



sunbather.com.au



A Fluidra Brand

Call Sunbather's highly
experienced team today.

1800 228 437



SOLAR HEATING



HEAT PUMPS



GAS HEATING



COVERS



ROLLERS

HEAD OFFICE

2174 Frankston-Flinders Rd,
Hastings Victoria 3915

T: 03 5979 5777
E: info@sunbather.com.au

SA

PO Box 2078
Morphettville SA 5048

M: 0419 033 930
E: sa@sunbather.com.au

QLD

25 Industrial Crescent,
Willawong, QLD 4110

T: 07 3806 5909
E: info@sunbather.com.au

WA

Midvale, WA, 6056

T: 1300 669 047
E: wa@sunbather.com.au

NSW

1 Herbert Place
Smithfield NSW 2164

T: 02 9894 7550
E: info@sunbather.com.au

NZ

Unit 1, 18 Corinthian Drive,
Albany, Auckland New Zealand 0632

M: +64 21 0233 2600
E: justin@sunbather.co.nz